

---

**CHAPTER 4.  
CARBURETION**

**CARBURETOR** ..... 4-1  
SECTIONAL VIEW ..... 4-2  
REMOVAL ..... 4-4  
DISASSEMBLY ..... 4-4  
INSPECTION ..... 4-7  
ASSEMBLY ..... 4-8  
INSTALLATION ..... 4-11  
ADJUSTMENT ..... 4-11

# CARBURETION

## CARBURETOR

- ① Connection arm
- ② Jet needle set (Primary)
- ③ Throttle valve
- ④ Coasting enricher assembly
- ⑤ Needle valve set
- ⑥ O-ring
- ⑦ Main nozzle (Primary)
- ⑧ Main jet (Primary)
- ⑨ Pilot jet
- ⑩ Pilot screw set
- ⑪ Throttle screw set
- ⑫ Float
- ⑬ Starter plunger set
- ⑭ Drain screw
- ⑮ Main jet (Secondary)
- ⑯ Main nozzle (Secondary)
- ⑰ Secondary piston
- ⑱ Jet needle set (Secondary)

SPECIFICATIONS		
	PRIMARY	SECONDARY
MAIN JET	#118	#100
JET NEEDLE	5C3F	5271
PILOT JET	#46	
PILOT SCREW	$2 \pm 1/2$	—
STARTER JET	\$0.64	—
FUEL LEVEL	6.5 ~ 7.5 mm (0.26 ~ 0.30 in)	—
FLOAT HEIGHT	H26 ~ 28 mm (1.02 ~ 1.10 in)	—
ENGINE IDLING SPEED	1,250 ~ 1,350 r/min	—

4

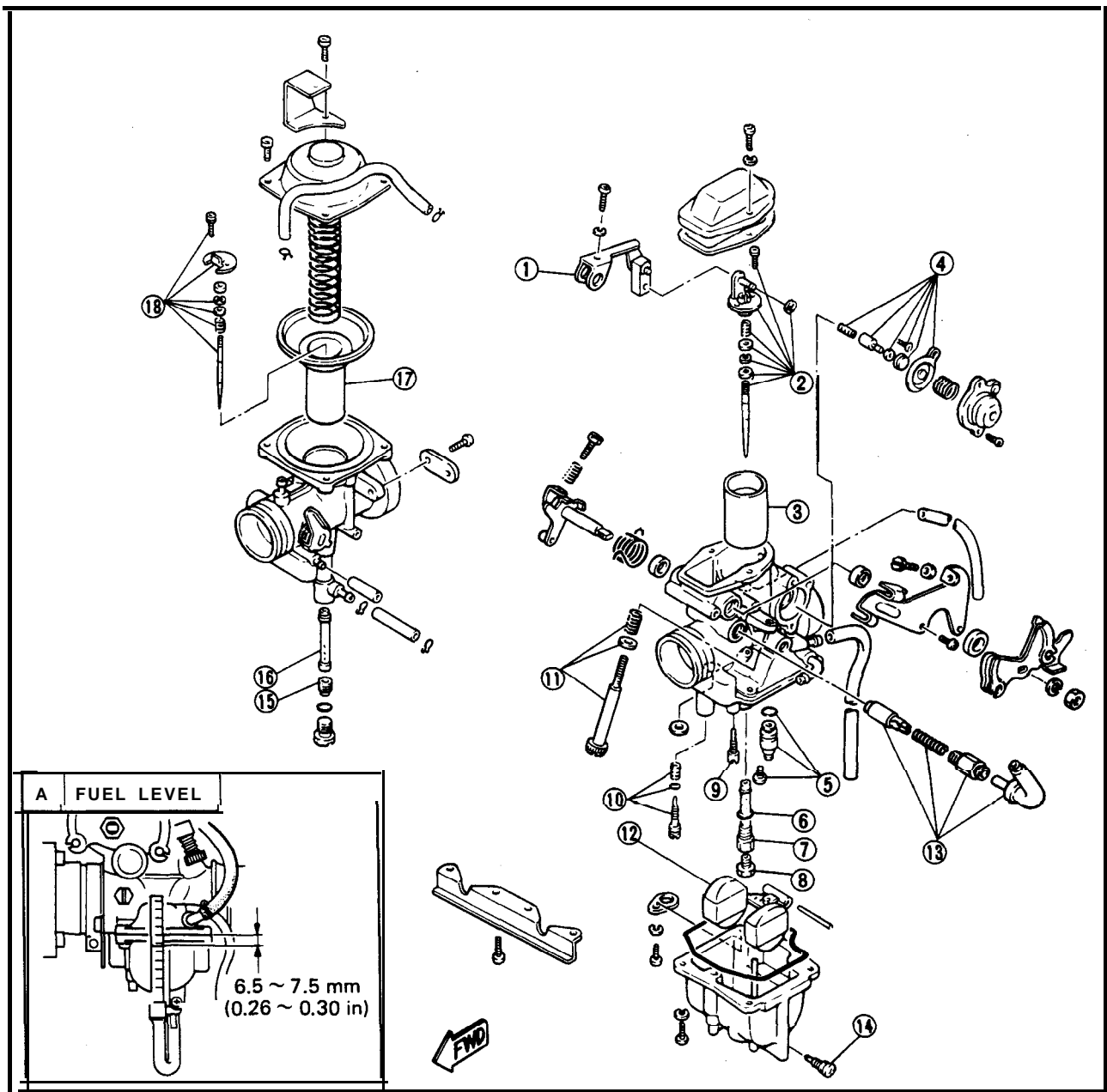

SECTIONAL VIEW

- ① Rod (Coasting enricher)
- ② Diaphragm (Coasting enricher)
- @Air jet (Secondary)
- @Air jet (Primary)
- @Air jet (Coasting enricher)
- ⑥ Needle valve
- @Pilot air jet
- @Main jet (Primary)
- @Main nozzle (Primary)
- @Pilot jet
- ⑪ Pilot screw
- ⑫ Pilot air passage
- ⑬ Primary air passage

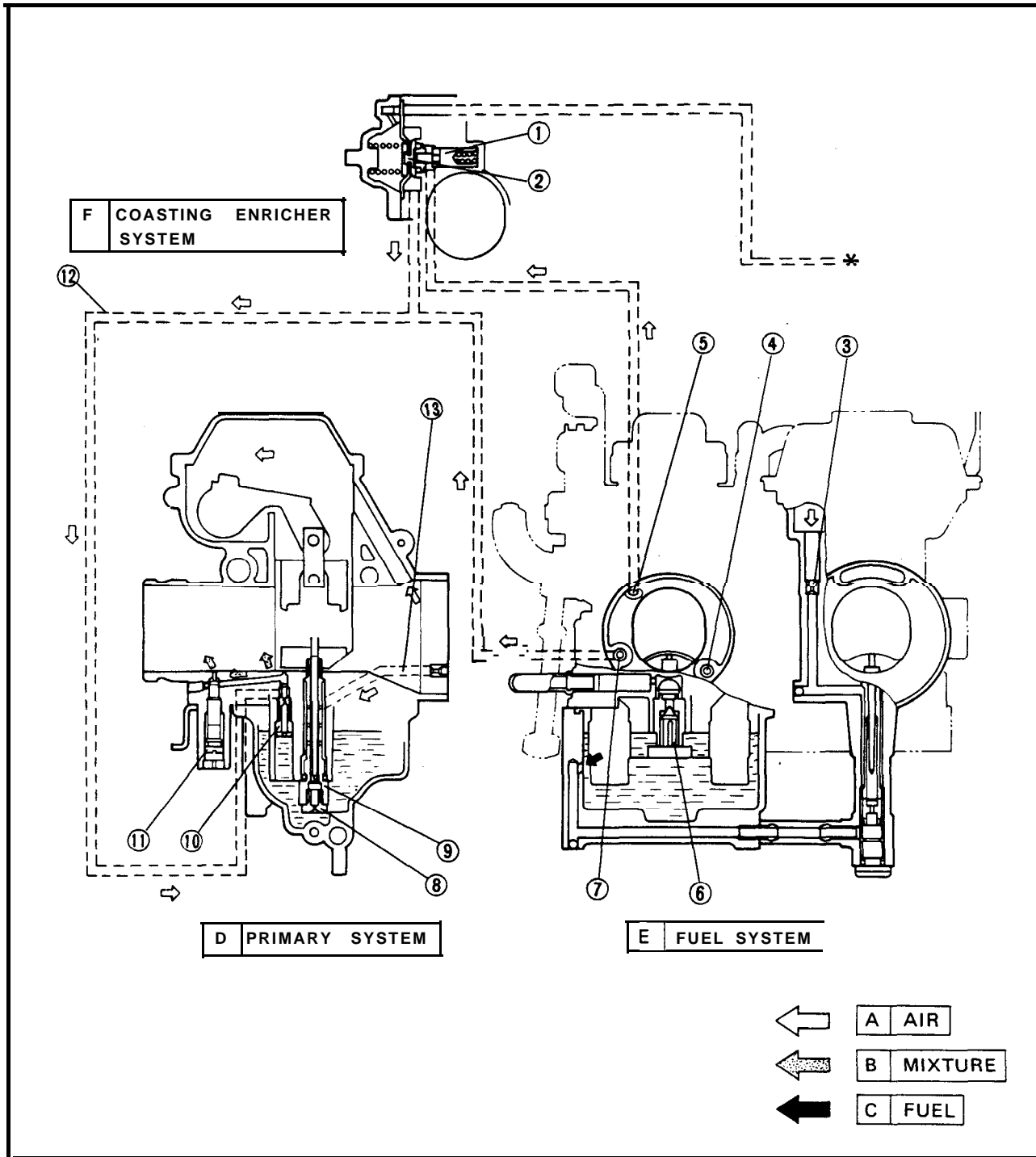

**4**

- ① Throttle valve (Secondary)
- ② Main jet (Secondary)
- ③ Main nozzle (Secondary)
- @Starter valve
- ⑤ Starter jet 1
- ⑥ Starter jet 2
- @Starter plunger

**4**

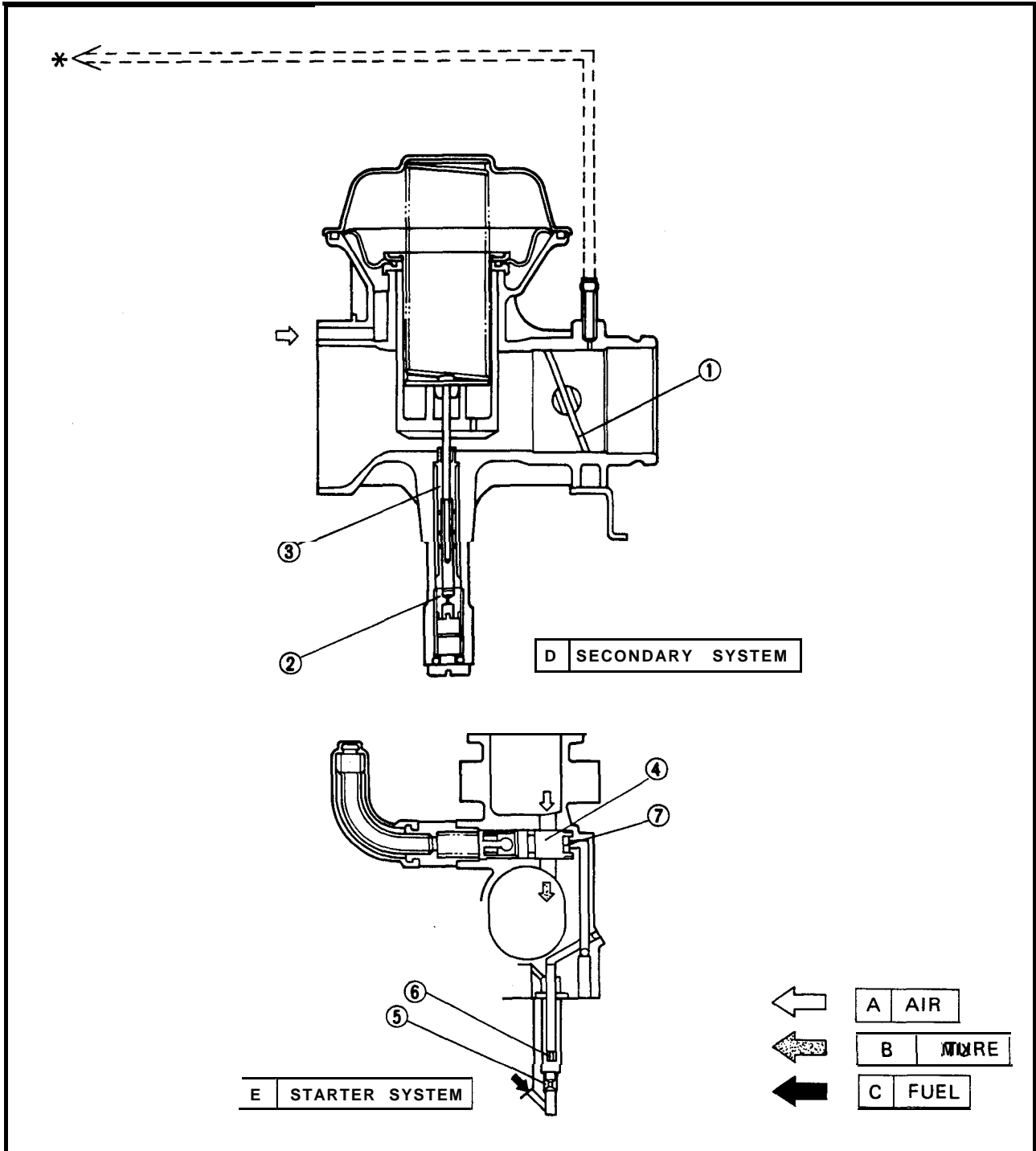



**REMOVAL**

1. Remove:

- Carburetor assembly  
Refer to engine removal section.

**NOTE:**

The following parts can be cleaned and inspected without disassembly.

- Coasting enricher
- Starter plunger
- Throttle stop screw
- Throttle valve

**DISASSEMBLY**

Primary and Secondary Carburetors

1. Remove:

- Stay plate (Upper) ①
- Stay plate (Lower) ②

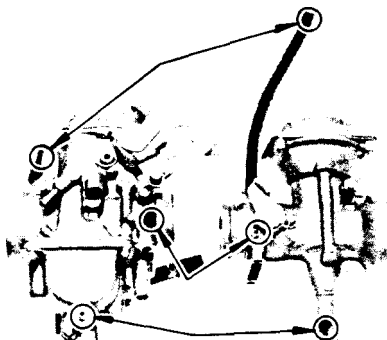
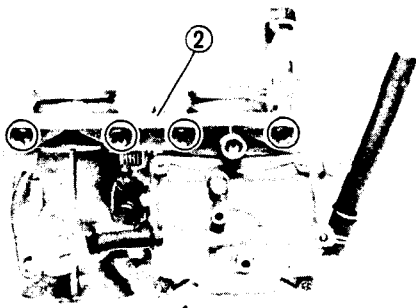
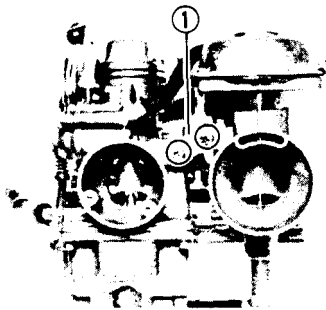

2. Separate:

- Primary carburetor
- Secondary carburetor

**NOTE:**

The primary and secondary carburetors are connected by the rubber balance pipe, the fuel line and the vacuum pipe. To separate the carburetors, pull them apart, applying an equal amount of force on each carburetor.

**Primary Carburetor**

**1. Remove:**

- Primary carburetor cap ①



**2. Remove:**

- Nut (Throttle shaft) ①
- Throttle lever ①
- Collar ②

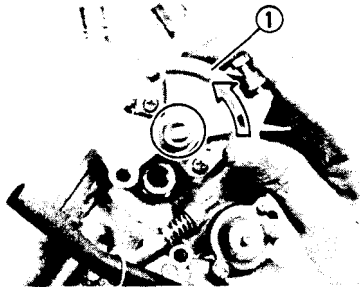

**NOTE:**

When removing the throttle lever, push the spring with one hand as they will turn.

- Screw (Connection arm) ③
- Spring ④
- Throttle cable holder ⑤

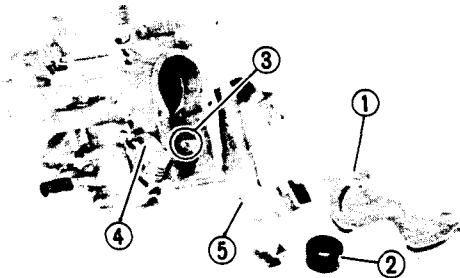

**4**

**3. Remove:**

- Throttle shaft ①
- Throttle valve assembly ②

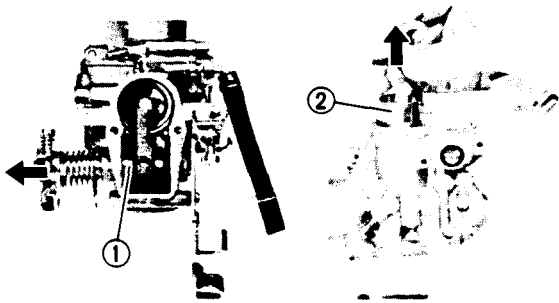

**4. Remove:**

- \*Connection arm assembly ①
- Spring ②
- Jet needle assembly ③
- Plate ④
- Throttle valve ⑤

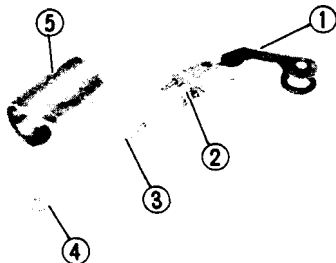

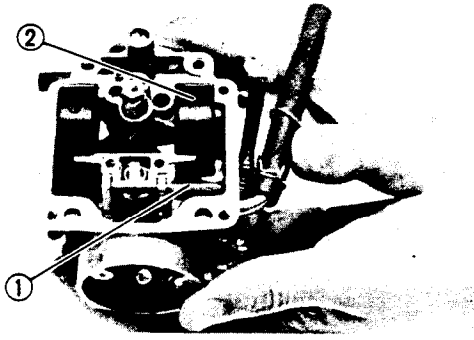

5. Remove:
- Float chamber cover ②
  - Float pin ①
  - Float ②

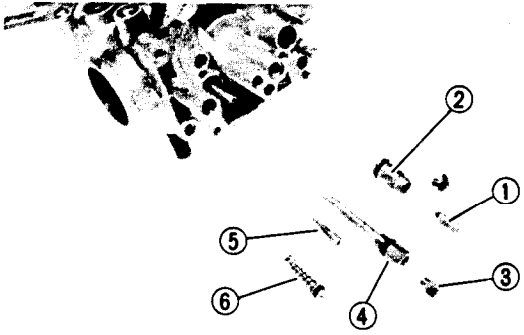

6. Remove:
- Needle valve ①
  - Valve seat ②
  - \*Main jet ③
  - Main nozzle ④
  - \*Pilot jet ⑤
  - Pilot screw ⑥

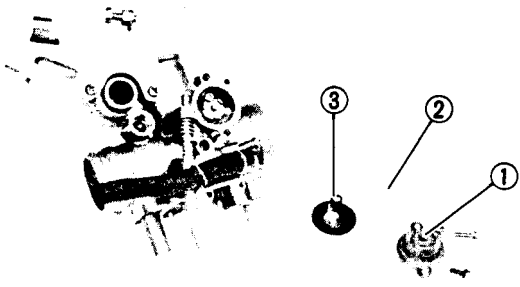

7. Remove:
- Coasting enricher cap ①
  - \*Spring ②
  - Diaphragm ③

**4**

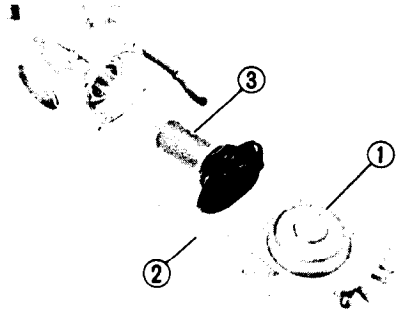

Secondary Carburetor

1. Remove:
- Secondary carburetor cap ①
  - Spring ②
  - Vacuum piston assembly ③

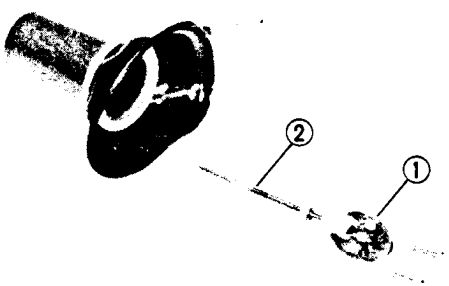

2. Remove:
- Plate (Jet needle) ①
  - Jet needle assembly ②

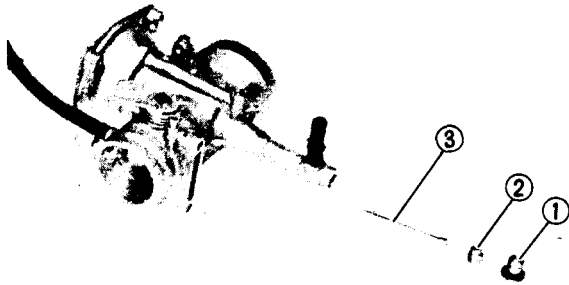

3. Remove:
- \*Drain plug ①
  - Main jet ②
  - Needle jet ③

**INSPECTION**

1. Inspect:
- Carburetor body  
Contamination → Clean.

**NOTE:** \_\_\_\_\_  
Use a petroleum based solvent for cleaning.  
Blow out all passages and jets with compressed air.

2. Inspect:
- Float ①  
Damage → Replace.
  - Gasket/O-ring  
Damage → Replace.

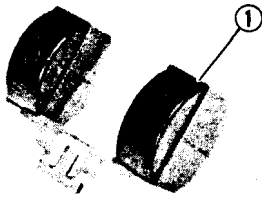

3. Inspect:
- Valve seat ①
  - Needle valve ②  
Wear/Contamination → Replace.

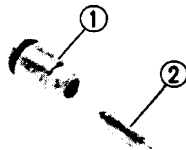

**NOTE:** \_\_\_\_\_  
Always replace the needle valve and valve seat as a set.

4. Inspect:
- Throttle valve (Primary) ①
  - Vacuum piston (Secondary) ②  
Wear/Damage → Replace.

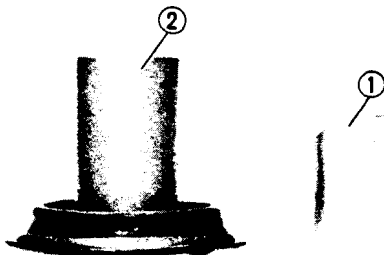
**4**





5. Check:

- Free movement  
Stick → Replace.  
Insert the throttle valve and vacuum piston into the primary and secondary carburetor bodys, and check for free movement.

6. Inspect:

- Jet needle (Primary) ①
- Jet needle (Secondary) ②  
Bends/Wear → Replace.

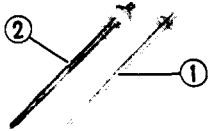

7. Inspect:

- \*Starter plunger ①  
Wear/Contamination → Replace.

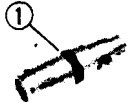

**4**

8. Inspect:

- Diaphragm (Coasting enricher) ①
- Diaphragm (Vacuum piston) ②  
Damage → Replace.

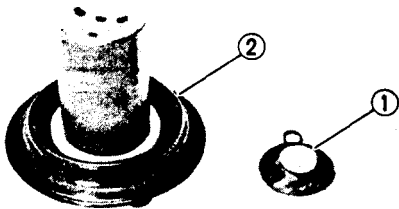

**ASSEMBLY**

To assemble the carburetors, reverse the disassembly procedures. Note the following points.

**CAUTION:**

\*Before reassembling, wash all parts in clean gasoline.

- Always use a new gasket.

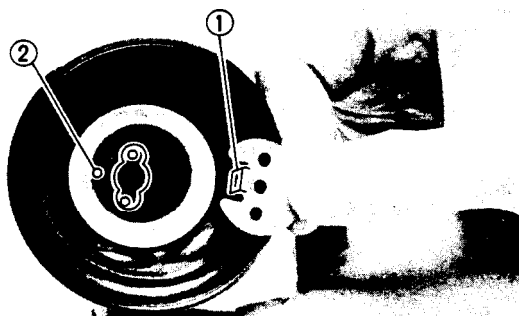

**Secondary Carburetor**

1. Install:
  - Jet needle assembly  
To the vacuum piston.

**NOTE:** \_\_\_\_\_  
 Be sure to install the plate so that the tang ① is located toward the hole ② in the vacuum piston.

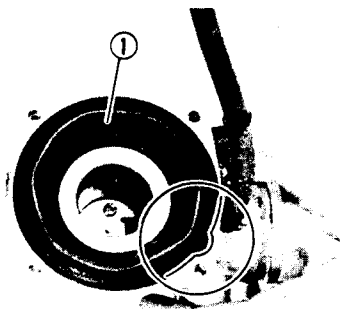

2. Install:
  - Vacuum piston ①

**NOTE:** \_\_\_\_\_  
 Match the tab on the diaphragm to the matching recess in the vacuum piston.

**Primary Carburetor**

1. Install:
  - Diaphragm ①

**NOTE:** \_\_\_\_\_  
 • Match the tab on the diaphragm to the matching recess in the coating enricher.  
 • The round lip ② side face to carburetor body.

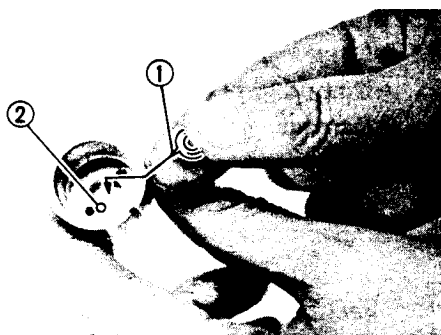
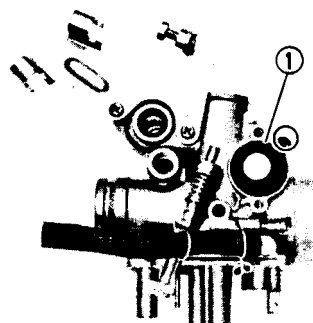
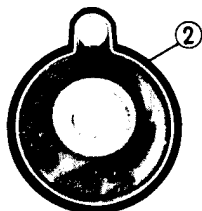

2. Install:
  - Plate  
To the throttle valve.

**NOTE:** \_\_\_\_\_  
 Insert the projection ① on the plate to the hole ② in the throttle valve.

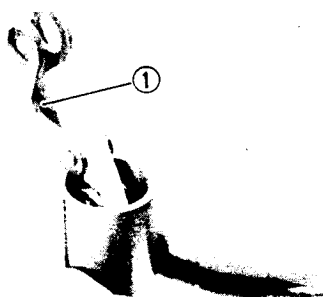

3. Install:
  - Connection arm assembly ①  
To the throttle valve.

**NOTE:** \_\_\_\_\_  
 Make sure that the connection arm assembly is at the illustrated position.

**4**

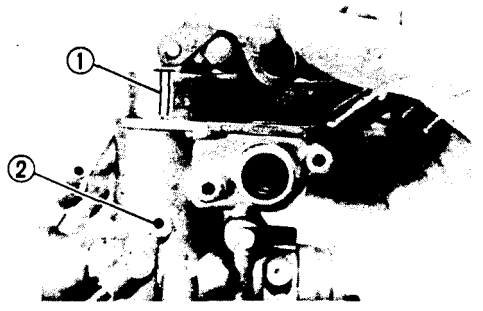

4. install:  
 \*Throttle valve assembly

NOTE: \_\_\_\_\_  
 Align the groove ① of the throttle valve with the projection ② of the carburetor body.

5. Measure:  
 • Fuel height  
 Out of specification → Adjust.

Float height measurement and adjustment steps:  
 • Remove the float chamber.  
 • Hold the carburetor in an upside down position.  
 • Measure the float height ① between the mating surface of the float chamber (gasket removed) and top of the float using a gauge.

NOTE: \_\_\_\_\_  
 The float arm should be resting on the needle valve, but not compressing the needle valve.

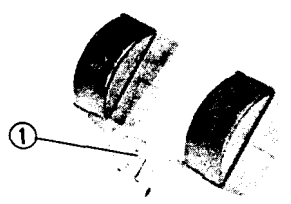
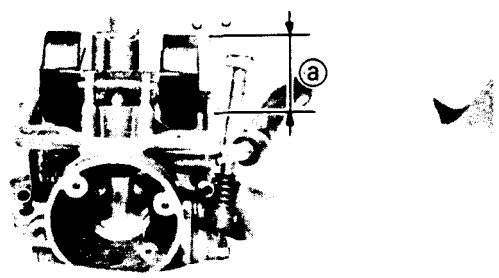

	<p>Float Height ① :                  26 ~ 28 mm (1.02 ~ 1.10 in)</p>
<ul style="list-style-type: none"> <li>• If the float height is not within specification, inspect the valve seat and needle valve.</li> <li>• If either is worn, replace them both.</li> <li>• If both are fine, adjust the float height by bending the float tang ① on the float.</li> <li>• Recheck the float height.</li> </ul>	

**4**

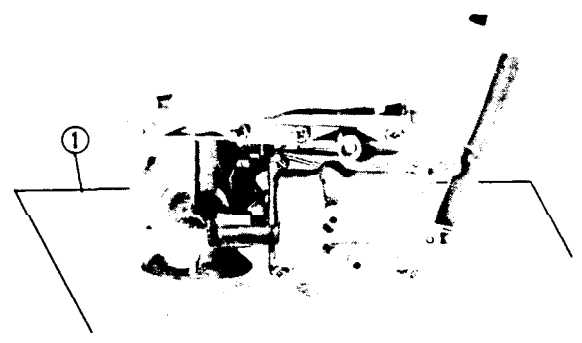

- Primary and Secondary Carburetors
1. Install:  
 \*Stay plate (Upper)  
 • Stay plate (Lower)

NOTE: \_\_\_\_\_  
 When reassembling, the surface plate ① should be used for proper carburetor alignment.



## INSTALLATION

1. Install:
  - Carburetor assembly
 Reserve the removal procedures.

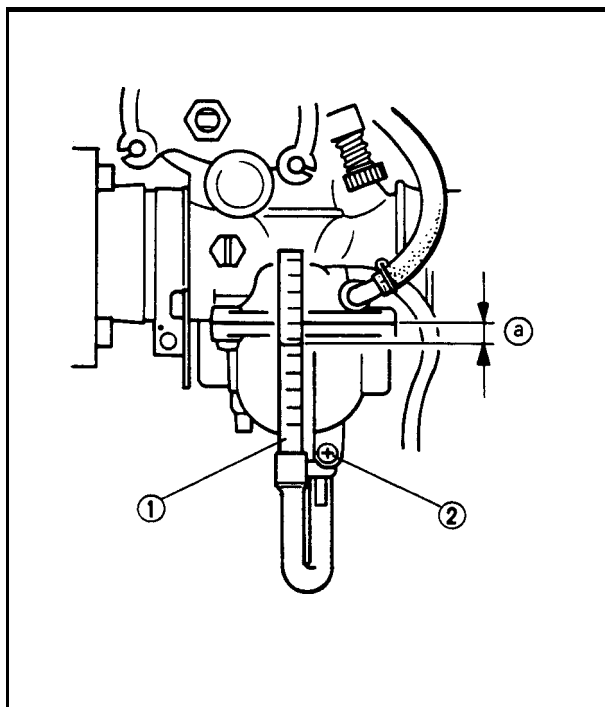

## ADJUSTMENT

### Fuel Level Adjustment

#### NOTE:

Before adjusting the fuel level, the float height should be adjusted.

1. Measure:
  - Fuel level (a)
 Out of specification → Adjust.

#### Fuel level measurement and adjustment steps:

- Place the motorcycle on a level place.
- Use a garage jack under the engine to ensure that the carburetor is positioned vertically.
- Attach the Fuel Level Gauge ① (YM-01312-A) to the float chamber nozzle.
- Loosen the drain screw ②, and warm up the engine for several minutes.
- Measure the fuel level (a) with the gauge.



Fuel Level (a) :  
6.5 ~ 7.5 mm (0.26 ~ 0.30 in)  
Below the Carburetor Body Edge



- If the fuel level is incorrect, adjust the fuel level.
- Remove the carburetor.
- Inspect the valve seat and needle valve.
- If either is worn, replace them both.
- If both are fine, adjust the float height by bending the float tang ① on the float.
- Recheck the fuel level.

# 4

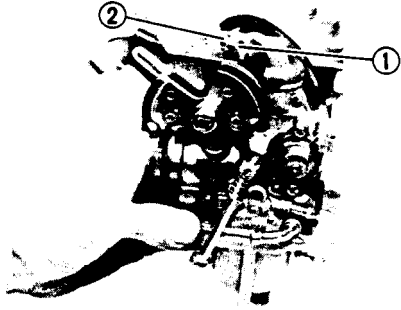

Primary Carburetor Full-open Adjustment

1. Adjust:

- Throttle valve position

Throttle valve position adjustment steps:

- Loosen the locknut ① .
- Turn the throttle grip to move the drum wire assembly to the full-throttle position.
- Turn the adjuster ② in or out so that carburetor valve bottom is positioned within the limits as specified.



Throttle Valve Position (a) :  
0 ~ 1.0 mm (0 ~ 0.04 in)

\*Tighten the locknut.

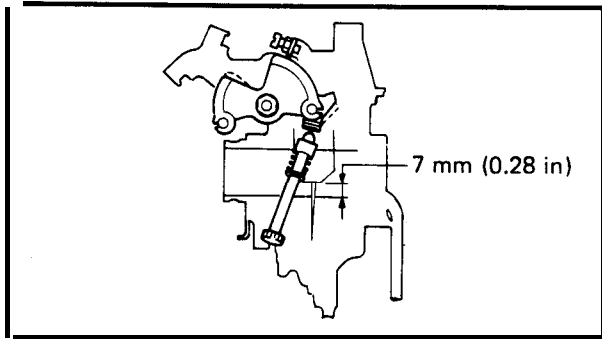
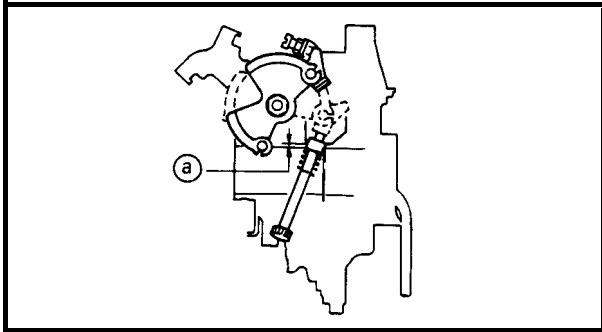

Secondary Carburetor Synchronization

1. Adjust:

- secondary carburetor synchronization

Secondary carburetor synchronization adjustment steps:

- Raise the primary carburetor valve to a height of 7 mm (0.28 in) as indicated.
- \*Adjust the synchronizing screw ① so the secondary throttle shaft just contacts the secondary throttle push lever.
- \*Make sure that the secondary valve ② is opened horizontally (A = B) when the primary carburetor valve is fully opened.

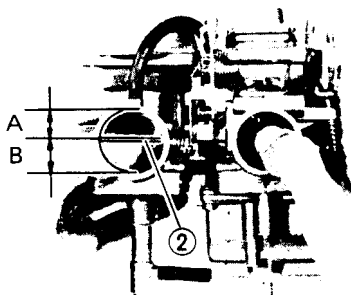
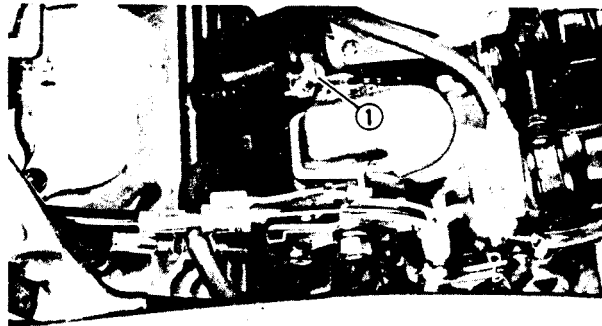

4